

TREES ARE FRIENDS!



**A ZINE ON
BUILDING
TREEHOUSES**

hey,

This zine was written in winter 2021/22 as an attempt to gather and share knowledge of our movement about living and building up in trees.

We're neither studied engineers nor arborists. We gained our knowledge by living in occupations, trying out things and making mistakes. If you think some information in this zine is wrong it is very possible so don't trust this zine more than needed. We are all still learning and making mistakes.

We don't explain here how to climb, make knots or other basic things you should know before building a tree house. It would be shit to learn climbing from a book anyway. If you don't know about these skills yet visit an existing occupation or get in touch with an action climbing group nearby. The purpose of this text is not to explain everything from the very basics but to help people who already have some idea about tree climbing to build nice and safe treehouses.

We have experiences with treehouses staying just for a few months or years. After that either the cops came with their machines and destroyed everything or the struggle is won and the houses get deconstructed (usually the first option). If you wanna build a treehouse elsewhere than in an occupation and it is meant to stay for a long time you might need to do some things differently than how we describe them here.

We gathered our experiences mostly in occupations in Germany and nearby countries. At the time of writing this zine there are about 10 forest occupations existing only around there and more in other countries. Therefore the idea came to write down experiences about building in trees so that more people in our movement can build up in trees by themselves without being dependent on a few experienced people from previous occupations.

After a struggle around Hambach forest and Dannenrod forest occupations and their big evictions we can watch now a movement of forest and land occupations coming up in our region. But if we really want to be a movement which can protect forests and confront state and capital we need to work on it. We have many occupations and now it is the time to work on communication structures, safe bases, development of new tactics, strategical thinking and ability to get new people involved and share skills. This zine is an attempt to take part in this process. Please share this zine as much as you like.



If you want to contact us you can do that here: treesarefriends@riseup.net

Polyprop

For building in trees we largely use polypropylene rope. We call it shortly polyprop. We buy only polyprop with certified breaking load so we know how strong it is. We buy polyprop usually from one specific company with a tradition in producing tough ropes for sailing. If you wanna know where to buy polyprop- ask in an existing occupation. Polyprop from construction stores is usually shit and has a much lower breaking load.

It might seem that polyprop is indestructible material which can hold everything but there are a few things which we should be attentive about. First of all polyprop degrades under sunlight (UV-exposure). So if you store polyprop for a longer time it should be covered. If you have for example traverses in use for a longer time (multiple years) you might think about exchanging it for new one as it is getting weaker over the time by sunlight.

Another issue is that if there is constant pressure on it polyprop gets longer. So for example if you hang a heavy platform it will hang some centimeters or tens of centimeters lower after some time. It is not too big of a problem if your polyprop gets a bit longer but it weakens the rope so if it gets longer too much at some point it might simply break. So if your structures remain for, let's say, more than a year you should keep an eye on it.

Forest occupations often need a lot of polyprop but from our experiences a lot of it gets wasted for constructions which don't need such strong rope. To reduce the waste of polyprop it can help to have always a lot of random recycled strings available and communicate to new people that they should rather use something else than polyprop for hanging their drying laundry. Another thing which helps is to have smaller diameter polyprop. Even if you try hard some people will always use polyprop for unnecessary things and from experiences if the thinnest polyprop is 8mm they will hang their clothes on it but if the thinnest polyprop is 4mm they will often use that so when you're making a polyprop order for an occupation it might make sense to buy some of the thin polyprop to reduce waste of the thicker one.

Other useful thing can be having somewhere a board explaining how to use different diameters of polyprop. One of our boards was saying something like this:

4mm We use for stuff which doesn't need to hold much.

6mm For hanging hammocks, swings, skypods... For small tripods.

8mm For binding main beams of platforms in trees.

10mm For lower part of walkways. For the knot of big tripods.

12mm For hanging small platforms. Some people use it for traverses.

14mm For hanging platforms. Some people use it for traverses.

16mm For hanging heavy platforms or special constructions like extremely long traverses

You basically don't need polyprop for anything else than fixing platforms, traverses and similar things in trees. For every connection which is not with a living tree you could use nails, screw or bolts.

Breaking load of polyprop we use:

4mm -> 2.8kN

6mm -> 6kN

8mm -> 10kN

10mm -> 15kN

12mm -> 21kN

14mm -> 28kN

16mm -> 37.5kN

18mm -> 45kN

Breaking load is the point where the material breaks. **Never work with breaking load!**

Usually working load (WLL) is used when building++. The WLL is much lower (divide the breaking load by 5).

And of course we have to count the fact that the knots reduce the breaking load up to 50%. For example clove hitch: -35% and blake: -25% .

About different kinds of trees

Oak (in German Eiche)

+ Oaks have very strong wood and a deep root system which makes them very stable and good for building. A modest tree house will not add significantly much more weight and wind-surface relative to the crown it is used to bearing. Don't exaggerate though!

+ Oaks having grown old and tall in forests often have very suitable crowns as the trunk divides into several sturdy branches at high altitude.

+ The rough bark does not require additional cambium protection when lashing. Even lashings that are not perfectly tight are unlikely to slide down much.

- In Germany and around many oaks suffer from oak processionary caterpillars (Eichenprozessionsspinner). We usually call them Eichis. The caterpillars feed on leaves of oaks – which can cause serious defoliation and stress to the trees - and their hairs are corrosive to humans and other animals. Contact with them can cause skin irritation, itching, respiratory problems, headache and possibly other problems. The contact doesn't need to be direct. It is enough to touch for example a branch where they have walked before. If there is a big population of them the hairs can also spread with wind through the air and cause itching on the whole body. The caterpillars are fairly small and very hairy. They build their nests on branches which look like a big mess of spider webs.

The peak of the Eichi-season is in May, June and July. If you have many infected oaks it can be enough to be on the ground in the forest and your body is itching and driving you crazy. In July they develop into moths and fly away. Afterwards there are just the dead nests left which you should remove but it is not that big of an issue anymore.

If you wanna build on oak you should check for the nests and think about removing them. It is possible to coexist with the caterpillars, and this has been done on oaks with relatively low numbers of them, but even otherwise fervent vegans have ultimately chosen to eliminate them. When dealing with Eichis one should be very careful. You want to have long sleeves, gloves and other protective gear. Also skiing or diving goggles are important so that you don't get eichi hairs in your eyes. Sometimes people wore whole body rainproof rubber clothes from German military to minimize the risk of getting in touch with the hairs of Eichis - which often results in very funny scenes.

If you wanna remove Eichi nests it is good to spray on it with spray paint so that their hairs stick together and can't fly around. People also often use hairspray but we had better success with spray paint. When they are sprayed you can either collect them in a bag or burn them. Eichis often like to build their nests under bindings of platforms which make it harder to remove because you don't wanna put paint on a rope holding your life (paint can weaken the rope).

Beech (Buche)

+ Hard and strong wood together with stable and deep root system makes beeches very stable. - Beeches often have sharp V-splits of branches and one should try to not build on such branches (see chapter Checking trees).

- They have very thin bark so use bark protection!

Spruce (Fichte)

- Spruces have soft wood which can easily break.

- Spruces are not well adapted to grow in central Europe, where they are often planted, which causes that:

- roots don't grow deep but spread on surface which causes in our area that spruces can easily fall in wind. It is not safe to be in spruce forest during strong wind.

- In central Europe spruce trees suffer often bark beetle (borckenkäfer). Bark beetles eat the tree which often leads to the death of the tree. If your spruces are not dead yet they might die soon.

- Use tree protection.

+ Spruce trees are usually planted near to each other so it is often easy to find a place to build big platforms in between several trees. These should not be built too high though: they should rather work to hold down the base of the trees than to add to the leverage of a tugging storm working to uproot the trees.

+ Same as most other needle trees they grow fairly tall and near to each other which can allow one to build complex traverse systems.

Pine (Kiefer)

- + Pines have a deep growing main root which fixes them strongly to the ground. In strong wind they are not that likely to fall as spruces for example.
- > Pines are very flexible which makes that they move a lot which can be annoying for living on them but it makes them resisting winds fairly well.
- Especially in upper parts of the tree the bark is very thin and even with a little injury the tree produces a lot of resin. If you build in pines you should be very careful about this. Use tree protection for every knot you make. Even for traverses or climbing rope. We experienced many pines getting hurt a lot by our constructions when tree protection was missing. First of all we shouldn't hurt trees which we wanna protect but also if the trees get hurt they produce tree resin which can then go on our ropes and decrease their strength. After only a few months living in a pine forest we needed to remove ropes which were fully soaked with tree resin.
- If you bind platforms between several trees you should not build it very high. Pines move super much and if you bind them too high you restrict their individual movement. It depends on the thickness of the trees but generally I'd say you should not bind them higher than in 5 meters. If you wanna build higher hanging is a better option.
- in strong wind it can happen that the upper part of the tree breaks down and falls on you.

Fir (Tanne)

- +Fir trees usually have deep main root similar as pine trees.
- We don't have much experience with them but probably they are quite similar in their characteristic to other pine trees.
- Use tree protection.

Douglas fir (Douglasie)

- + Douglas fir has (for a needle tree) quite hard wood and good and deep roots which makes it safe and a good tree to build.
- + They grow very tall. If you have a grown-up douglas fir in your forest it is likely to be the highest tree.
- + In comparison to spruces they are more resistant to drought..
- ♥They are pretty.

All the mentioned needle trees grow usually a straight trunk. If the trunk has some funny bend it means probably that the top of tree broke down in past. Such bend is a weak point where the tree is likely to break again. So especially if you wanna bind a platform between few needle trees (and by doing that restrict their movement) you should check to build on straight trees.

Hornbeam (Hainbuche)

- +Hornbeams have very hard wood so they can be built on.
- You don't find usually very big and old hornbeams because when they grow big they at some point fall. You can sometimes find fallen hornbeams on the ground which still have green leaves and no obvious reason why they fell. So some of us think it is not really good to live for longer time on hornbeams because one day the tree might just fall with you on top.
- + They have often many branches starting already shortly above ground which make them easy to free climb.
- They usually don't grow so big so you can build just small platforms on them unless you use multiple trees which should be fine.

Aspen, poplar (Zitterpappel, Pappel)

- Aspen and poplar have extremely soft wood which makes the branches easy to break.
- They have flat root system which higher the risk of a tree falling in wind.
- If you have other trees simply don't build on those...
- + If one has no other trees available than poplar and willow (see next), as can be the case in riparian pioneer forests, one can try to make the best of the situation by building low constructions between multiple trees and traverses and/or smaller platforms higher up. One should be very careful to check the health of the trees and the relevant branches.

Willow (Weide)

- + Like alder they often grow on river banks or in wetlands, providing an inconvenient surface for eviction equipment.
- Willows are remarkable in their ability to survive serious damage and torn off branches; the tree-house builder is less likely to deal with broken limbs quite as easily. This species is too fragile for high single-tree constructions. Use for traverses or short-term platforms on low altitude can be considered, as well as multiple-tree constructions on low altitude. As with poplars: use it if there is nothing better available but do so very carefully.

Tilia/Lime (Linde)

- + This species has become rare as a forest tree but is often seen in villages or city forests
- + Structurally, the tree should be strong enough to support a tree house..
- Old linden growing in villages or along lanes tend to have low and dense crowns where it would probably be rather hard to build

Birch (Birke)

- Generally unsuitable. Birches are fast-growing pioneer trees that are neither sturdy nor do they have good crowns.

Alder (Erle)

- Alders are fast-growing trees which have a tendency to break. Don't build high structures on them. Low-hanging platforms on large trees can be considered if nothing better is available.
- + Like willow they often grow on river banks or in wetlands, providing an inconvenient surface for eviction equipment.

Ash (Esche)

- + Ash trees have an extensive root system that anchors them firmly into the ground.
- + Ash wood is strong and flexible.
- European ash trees are plagued by an aggressive fungal disease.

Maple (Ahorn)

- No experience
- Be careful with branches splitting off (V-forks, see next chapter).

Black locust (Robinie)

- Their thorns are poisonous so just avoid them, even if their wood is hard.

Chestnut (Kastanie)

- No experience from us.
- Edible chestnut trees should be apparently stronger and more stable than normal chestnuts.

Platanes

- Those trees have small hair on their leaves, young branches and buds that produce skin and lungs irritation in many people.
- Sometimes the tree has an mushroom called massaria that kills the top half of branches and they might fall even when they still have green leaves. The top of the branches will take a light pink color when sick.

Checking trees

Before you decide to build a new home on a tree you should take a look on the health of the tree. You don't need to be a studied arborist to recognize some of the sicknesses and injuries. Here we list a few things you might want to look for.

- Look on the ground level all around the tree for **holes in the trunk**. If there is a hole take a stick and poke in with it. If the hole is not too deep and the wood is hard it should be ok. If the wood is soft and you can press the stick deep in the tree it might mean that the tree is hollow. Especially on spruce trees you should do the stick test. Spruces often have such holes and are hollow on the inside. You don't wanna live on a hollow spruce, and even less come crashing down with it!

- Check the **roots**. If there are many visible injuries the tree might not be the safest. If the roots of a tree have been injured recently, the branches above those roots might die soon. Same thing if a part of the crone has been damaged recently the roots under it might die and make the tree less stable.

- Check how the branches on which you wanna build divide from the trunk or other branches. There are two kinds of forks: forks in the shape of the letter U and forks in the shape of the letter V. U is good, V is not. The V-forks are more likely to break and it is recommendable to not build over V-forks. You can often see in a V-fork a kind of a scar where the branches divide (a deep line with reaction wood around it). On a nice stable U-fork there should not be such a scar or at least not a big one. If the scar is big and look like giants ears it is not good. The V-forks is a typical problem with building on beeches. If a beech grows inside of a forest and therefore doesn't have too much space it very often develops V-forks. If you wanna build in the canopy of a beech you should definitely check how the branches divide and possibly try to find another solution. Beeches are good trees but the branches still sometimes break off and this is the place where it happens.

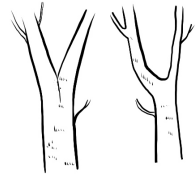

- If you can, take a tree which grows straight up and doesn't lean to one side. If your tree grew leaning to a side it probably developed either a pushing (typically coniferous trees) or a pulling root (typically deciduous trees). Pushing or pulling roots are strong roots which support a leaning tree to not fall. A pushing root is pushing against the direction of leaning, buttressing the trunk, and a pulling root is pulling in the same direction, anchoring the trunk. Pushing and pulling roots are usually visible and thick. If this root has serious damage the leaning tree is not very safe. If the roots are healthy, one should try to find out whether the tilted position of the tree is due to life-long tilted growth or whether a storm has pushed it thus. This can be done by looking at the axis of the trunk: is it straight, like a carrot, or is it bent, like a banana? If straight, it has probably been tilted more recently, which can be confirmed by checking the soil surface (the roots can lift up the ground a bit). Does it look or feel like it has been pulled up on the far side of the tilt? Then the tree has most probably been tilted by a storm, the roots having been pulled up as well. In this case, the tree will not have developed sufficient reaction wood to compensate for the tilted position and the roots won't hold it firm enough anymore – in this case it cannot be considered secure. If you can establish that the tree has naturally been growing somewhat diagonally over a long period of time, perhaps reaching for the light, with an undisturbed root system, you can trust it to carry a modest construction.

- Look if there is a lot of resin on the tree. Trees produce resin to heal their wounds, defend against insects and so on. If there is a lot of it on the tree it means that the tree has some problem.

- Check for mushrooms. If there are a lot of mushrooms growing from the tree, it is not good. Many fungi live in mutualistic symbiosis with trees, but mushrooms growing out of the tree itself indicate morbid tissue that is being metabolized by the fungus. Look for mushrooms (fruiting bodies of the fungus) or for mycelial cords under a loosened bark – a loose bark is anyway a bad sign! Weakened oaks, among other species, often get infected by armillaria root rot (Hallimasch), which has black or bioluminescent (glow-in-the-dark) mycelial cords. And others can be dangerous in a different sense: Maple trees with flaking bark, revealing black "dust" underneath, are an unmistakable sign of the fungus *Cryptostroma corticale* (Russrindenkrankheit). There is a risk of respiratory impairment due these fungal spores.

- Look if the tree is twisted. Sometimes trees grow twisted. That means that the wood fibers don't go straight up but go around the tree. If a tree is twisted you can see it. It is better to avoid building on a twisted tree. You can still build traverses on a twisted tree but you really have to take care that your traverse does not open the tree (it can break open like piece of polyprop you turn in the wrong direction if you pull on the wrong side of a branch) but rather turn it tighter. If you fix it on the trunk it should be ok (of course not if you already see that it is tearing apart)

-It is better to build on branches which grow rather vertically than horizontally. If the branch grows horizontally you should build not too far from the trunk and you should not put too much load on such a branch – especially not if it has a V-fork!

-Woodpecker holes might be dangerous because mold can get very easily there. Put a stick in it and knock on the tree under and over the hole to see if it is hollow.

-If there is too much dead branches your tree is maybe not super healthy. By oaks it is normal to have quite some dead wood, especially the lower branches. Some trees are dying from the bottom and some from the top so before building a treehouse look also in the highest part of the tree if the branches are not dying of.

- Sometimes there are two trunks growing from the same base which divides itself a meter or two or so from the ground. Such trees look often pretty and one would want to build on them but it might not be the best idea. The split of such tree(s) is probably a V-fork with very visible scar and is possibly (but not necessarily) already rotting in the split. The two trunks of such a tree move independently and the wind has a big surface to push and pull on the branches so the forces on the split in the bottom are huge. It might happen that the tree will just break in two and one of the two trunks falls. If you build a treehouse on such a tree you just add load and sail for the wind to push which makes it more likely for the tree to break.



- Take wind exposure into consideration. Is the tree, or the height in which you want to build, sheltered by other trees or not? If it is not sheltered, it is important to know whether it has grown up under constant wind exposure or whether the exposure has recently come about by the removal of other trees or even a whole section of the forest. Tree species develop resistance to wind as a matter of evolutionary adaptation through natural selection, but beyond this, individual trees develop resistance to wind in response to specific environmental conditions (phenotypic plasticity). When these environmental conditions change abruptly, the individual tree, even though belonging to a species that can deal with wind, might not be adapted to the new conditions and be more prone to falling or breaking. After a clear-cut trees that used to be sheltered in the middle of the forest suddenly find themselves at the edge, forming the first windbreak. Often, as can be seen at the edge of the Hambach forest (where drought also weakens them), these trees fail to withstand the full force of the wind. So be careful with building next to a clear cut. Especially building on less stable trees (like spruce) should be avoided next to a clearcut.

Similarly, sudden exposure to excessive direct sunlight can mean the undoing of trees that used to be sheltered in a more humid and shaded microclimate. Their bark will get sunburned and start peeling off. Beeches are vulnerable to this.

- If there are dead branches above the place where you wanna build your platform you might want to remove those branches so that you don't need to fear them falling on you or your treehouse in future.

- When building in a canopy, try to find a place for the house where you dont have to cut branches. Trees are friends!

- If a supposedly stable tree is densely overgrown with e.g. ivy, wild honeysuckle or woodland vines and you cannot see the trunk and branches completely (damages and V-twigs, rotting ...), do not choose the tree.

Before building on a tree it is good to talk with more people about it and ask for advise and others' opinions. If you build on less safe trees you don't endanger only yourself but all the other people who will at some point climb up there assuming that the builders knew what they were doing.

Fixing beams to the trees

There are a few ways of fixing beams up in trees. We have a lot of experience with binding and hanging. Other options of fixing beams are with bolts or special tree screws. Different options have different advantages and are more suitable in different situations.

Binding/ Lashing

Beams can be bound with rope to a trunk or branch of a tree. We usually use 8mm polyprop for binding. Bindings should be made **as tight as you can**. If you make bindings too loose it might slip down, hurt the tree and destabilize your construction. One way of tightening the knot as much as possible, is by clipping a carabiner onto the rope and following it all the way along the lashing, pulling as much slack out as possible, which is often remarkably much. After that you can choke the knot using your own bodyweight (footlock in the poly). Try to make the knot in the end as tight as possible! Binding, or lashing, can best be learned by direct practical instruction and imitation. We will not try to explain in this manual how to lay the rope into the correct knot.

When we occupied a pine forest we experienced that when bindings were not made tight enough the beam could move to the side as the trees were moving in the wind. By moving, the beams scratched all the bark from a tree in the area and made huge open wounds.

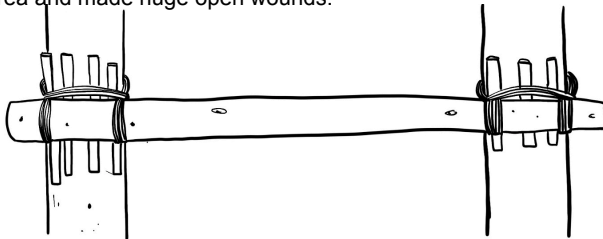
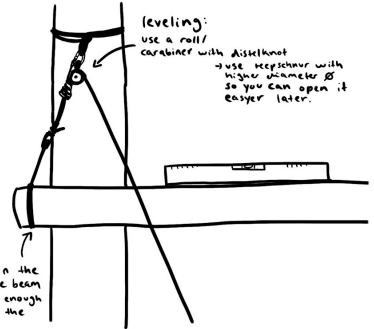

Hanging

One can simply hang a beam on branches or trunks of trees. For hanging we usually use 14mm or 16mm polyprop. If there is constantly load in polyprop it gets longer over time. Polyprop is strong so it is ok but with time while getting longer it gets weaker and at some point it might get weak enough to break. When platforms hang for a long time (a year or more) you might be able to see that the platform is hanging lower than it used to and you might want to exchange the polyprop. Also while hanging the polyprop has much more exposure to the elements and is also constantly under tension which makes it more vulnerable to damage. One can use also steel rope for hanging platforms more durably.

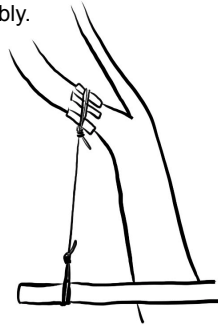
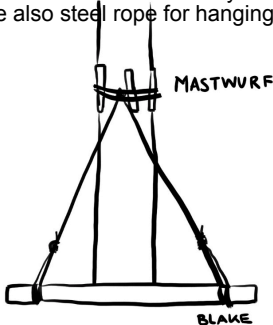

Bolts and other ideas

Another option of fixing main beams to the trees is by drilling a hole through both the tree and the beam and putting a big bolt through it. On the bolt you then screw a nut (with a washer, to prevent it from digging into the wood) and it should hold strong together. It might sound brutal to drill a hole through the tree but it is not that bad. The most important and vulnerable part of a tree is the cambium and adjacent phloem: a thin inner layer of the bark where sap moves up and down from the leaves and branches to the roots. By drilling a hole you disrupt the cambium just on two little spots which shouldn't be a big deal for a tree, as it is used to seal minor wounds caused by branch breakages and such. However, by drilling holes one obviously does wound the tree and the wounds can get infected with fungi and bacteria. Therefore it is important to choose a healthy tree that will be able to ward off potential fungal or bacterial infections.

An advantage of the bolt option is that there is no rope which could be rubbing through the bark or choking the cambium. Another advantage is that if the platform is meant to stay for multiple years you can simply loosen the nuts a tiny bit from time to time so that the branch (or trunk) can grow and get thicker. If you have bindings on a branch for a long time you restrict it from growing and therefore bolts might be a better long term solution. Unfortunately we were always loyal to polyprop and never tried this option (always expecting imminent eviction).

There is another option with bolts which doesn't involve drilling through a tree. You need two beams and you drill 2 holes in them. Then you put the beams each on one side of a branch and you put bolts through each of the holes to fix the two beams together. You screw the nuts tight which should make enough friction on the tree to hold the beam in position. Advantages of this option are the same as with the previous option plus that you don't have to drill through the tree itself. We don't have successful experiences with this technique – someone tried and found it very hard – and the applicability probably depends a lot on the shape, position and orientation of the branches or trunk one wants to use.

Capitalism produces everything. There are special tree screws for building tree houses. The tree screws seem to be a very good option for building tree houses which should last for very long time but in occupations we usually don't plan to live for decades and tree screws are bloody expensive. That does not mean that one should just use some old rusty board screws either! If you want to try this technique, make sure to get long, sturdy, stainless bolts.

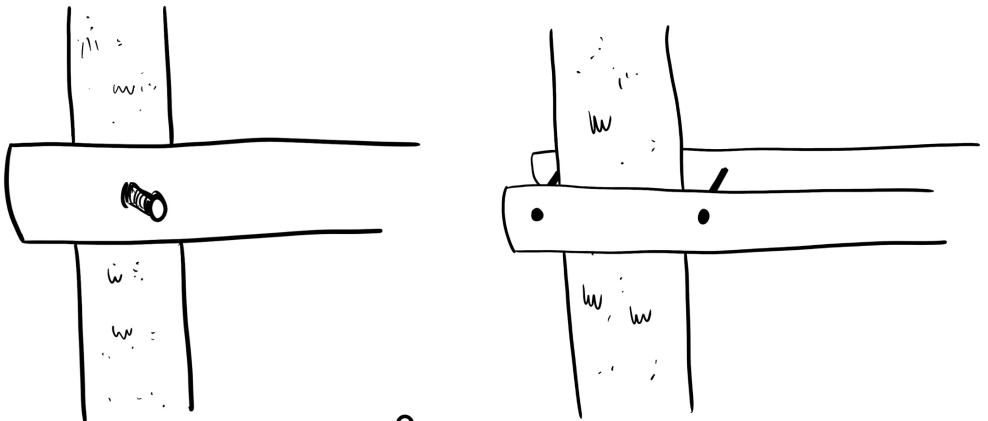

Tree protection - Stop putting carpets on trees!

Tying ropes around a tree can be problematic for the tree. The rope can damage the bark and make open wounds. If the rope is very tight around the branch or trunk it might choke the cambium and restrict the tree from moving sap and nutrition between roots and leaves or needles. Fortunately there are ways how to make it less harmful. Unfortunately what we sometimes do makes it even worse.

One of the first ideas people usually get is to simply put blankets or pieces of carpet or camping mattress under the knot to protect the tree. The problem is that these materials soak water and so they keep this place on the tree constantly wet and without fresh air. Such conditions attract mold, mushrooms and insects. The tree is not happy for either of those. It would probably be better to not use any tree protection than some like this.

An a bit better option is to use thick rubber which doesn't soak water. It is still not the best for the tree to be constantly covered but at least the place is not always wet and the polyprop can't cut directly into the bark. On one tree house we have used for some knots rubber, for other knots camping mattress. Two months later we removed it and there was a big difference between each knot. When I took off the mattress it smelled very strong, the branch was wet, there was mold and different bugs living there. But when I cut of the rubber it did not smell, the tree was dry and without mold or bugs.

What we currently think to be the best option is to put planks under the knot. We simply put pieces of planks around the branch under the knot so that the rope doesn't touch the bark. Like this some parts of cambium stay untouched, the tree can breathe more and it protects the bark. Before you go up on a tree it is nice to cut the edges of the planks with an axe or knife to make them less sharp so they can't damage the polyprop. You can put the planks under the rope while tying the knot or you can use an expander (the flexible cord with hooks on the ends) to hold the planks in position before the knot is made. There is a danger of a knot slipping down from the planks. To prevent this leave the planks overlapping under the knot for maybe 15cm or so.

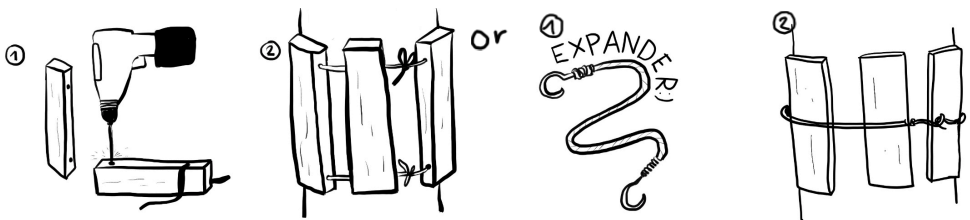

To put the treeprotection in place it can be nice to drill holes in the planks or squarebeams you are going to use, put elastic band trough the holes and fix it on the tree. For less effort put an expander around. Then you have your hands free to make the knot.

Using appropriate tree protection is an easy way to reduce damage to the trees on which we live; it should be a normal thing to use always when it is needed. We had multiple tree houses where people did not put tree protection while making the knots and we needed to fix it later when the tree houses were already finished. We had to lift up the tree houses to be able to put tree protection under the knots so if it would have been done in the first place it would have saved us a lot of work. After only a few months of occupying a pine forest we figured that many trees were getting hurt not only from tree houses but also from traverses or even climbing ropes fixed on them without tree protection. So if you're working with pines be extra careful and put tree protection under every knot otherwise you might make open wounds which will produce a lot of tree resin going directly in your ropes. Often tree houses in German forest occupations are built on oaks. Their bark is so thick and rough that most of us think no bark protection is needed, provided that the knots are well made and don't allow for too much rubbing while the tree moves in the wind.

Hanging platforms

The big advantage of hanging platforms is that you can build basically on any tree that is strong enough to hold the platform with no regard to the shape of its canopy. Another advantage is that you can choose what size of platform you wanna have. Disadvantage is that a hanging platform will always move more than the binded ones and it is less beautiful to live hanging somewhere on a trunk than to be in the middle of a canopy.

There are multiple ways to hang platforms:
 You can build the platform on the ground and pull it up. It is always easier to work on the ground than up in trees but also a finished platform is a heavy shit so it can be a pain in the ass to fix it in the right position and make the platform level once it's up.

Another option is to build on the ground only the frame of the platform. To build the frame you take two main beams and fix on them two crossbeams, one on each side. After the crossbeams leave about 10 or 20cm space

for knots and then nail on each side a thin board to ensure that the polyprop can't slip off, or make a notch into the beam for the knot to sit in so it can't slide out either. To make the frame stable, nail a thin beam or a plank from underneath the platform diagonally. The diagonal beam makes that the frame keeps its shape. If you are not planning to hang the beams straightly vertically, there is gonna be horizontal forces working on the beam. If your platform is gonna be hung with the ropes meeting in the middle (like in the picture on the bottom left), its good to put a beam in between the main beams and nail it from the side, otherwise they will collapse together. If the ropes are going outward(if the platform is hanging between two trees) the beam will be pulled outward aswell so it might be good to bind them together as a backup.

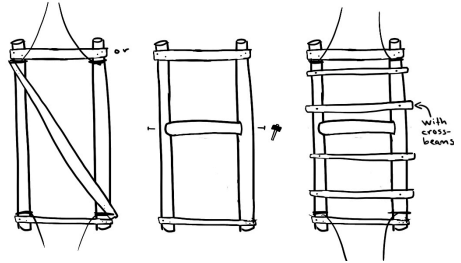

This frame you can than simply pull it up using a pulley system. Like this it is not so heavy so you can pull it up with little effort and it is easier to put the platform in its desired position and level it.

You can hang a platform on one tree but then you have a problem with the polyprop going diagonally through the space above the platform – basically the space where you would live or build your cabin.

A nicer option can be to hang a platform between two trees. In that case the ropes are out of the way and don't bother you while building the tree house. To pull a platform between two trees it is nice to make two independent pulley systems: one on each tree so that you can easily bring the platform up already in a horizontal position.

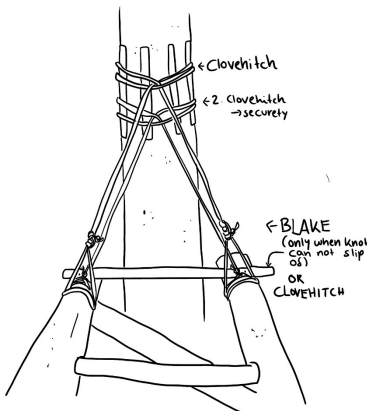

If the platform is only hanging it moves a lot and most people don't like too much of the sailboat feeling. To make sure the platform swings less it's nice to bind it at least on one place. If you can do more bindings it gets of course more stable (with also all the disadvantages of that) but even one is usually enough. If you don't wanna bind the platform you can also anchor it with ropes to the tree(s) under the platform. If the platform is hanging from above and also tied down it gets as well quite stable.

If you have a tree with two strong branches you can nicely combine hanging and binding. Once we built a nice platform which was both hung and bound in the canopy of an oak. The tree was dividing into two main branches so we bound each main beam in the middle onto a branch and hung it up in the ends. When we had the beams in the right position we nailed crossbeams and planks and got a nice stable platform. There are many different options how to combine hanging and binding and you can get creative with what a tree offers you.



If you are hanging something it is important to look at the angle you are hanging the thing. The wider the angle gets, the more force is applying. The least force you get when hanging something straight down, the most when trying to hang something horizontally (f. ex in a traverse). The forces are then multiplied and something will work way more force on the material as its actual weight. Be extremely careful when hanging things in a low angle. This applies also for traverses, which is the reason we are careful when putting them under tension. While tensioning the angle gets wider and wider, and the force gets bigger. This means you might go for the limits of your material! If you are working with a lot of tensions in traverses and wide angles in hanging it is really important to calculate the forces and use some mathematics and physics.

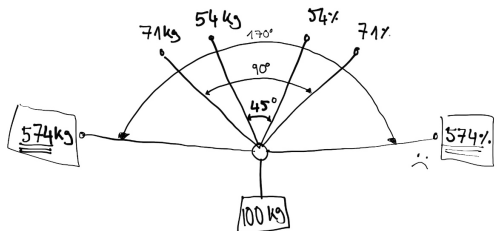
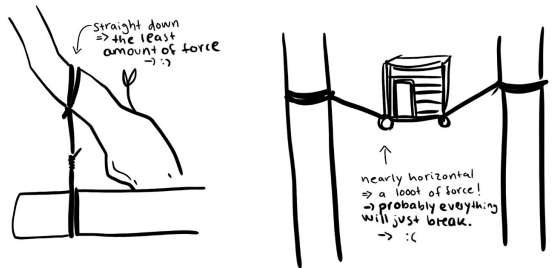

If you want to try this out, take a pallet with another person. First you lift it up straight from above. Then you try to grab it from the side and lift it up by pulling horizontally.

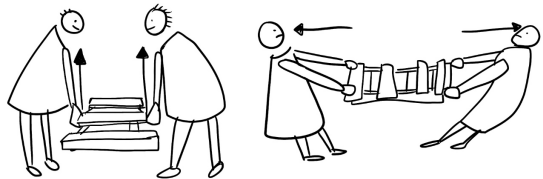

Also be aware that the polyprop will lengthen under the force of the weight of a treehouse. If you are hanging only one side, this side might get longer and you will end up in an unbalanced treehouse. To prevent that take strong polyprop for hanging (like 14 or 16mm). Its also good to have your treehouse secured more than once, then it lessens the force on one string of poly and you are also secured if one string should get damaged. If you are hanging very heavy stuff, learn how to deal with stealrope.

The only good system is a pulley system

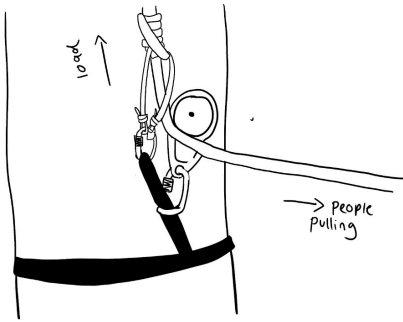

DISTEL

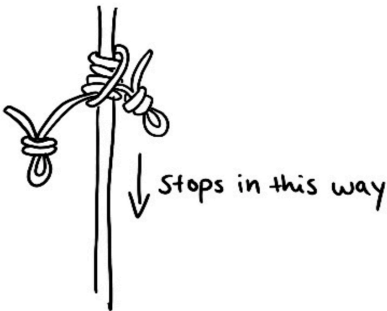

A lot of times when building treehouses you might want to pull up heavy stuff, like platforms or ovens or maybe entire treehouses. As a human that used to find them a bit creepy-a little explanation:

The idea of a pulley system is that you make something easier to pull up by making the way you are pulling longer. For a simple pulley system you are going to need bandslings, carabiners, pulleys, a static rope and a distel. The more pulleys you include the easier it gets to pull- but also the more rope you are going to need.

It's important to secure the pulley system so you can let go of the rope, without whatever it is that you are pulling up falling down again. That's what the Distel is for. Try to put the Distel at the end of the pulley system, in an easy accessible place, so that it can be checked on (that its not getting to hot or tearing or getting inside the pulley) while pulling. If the Distel has a bigger diameter, its easier to loosen it when need be and can hold more load. Make more loops to your Distel then. Another thing to be careful about is friction. Check if the ropes are creating friction on each other or if the ropes are rubbing on the tree. Friction makes it much harder to pull and destroys the rope! If you have differnt kind of pulleys take the one that can carry the biggest load as the one redirecting at the top, thats where the most force will be.

Build the pulley system in a way the people who pull are not standig under what they are pulling up and check that all the material you use can actually carry the load and is in good condition before starting!

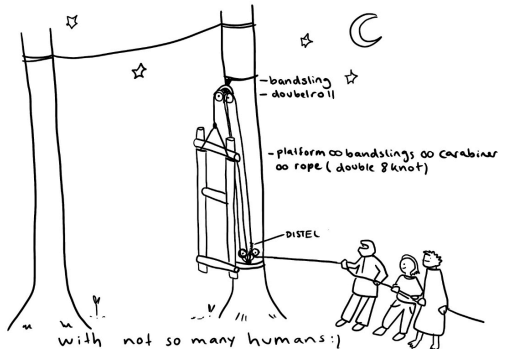
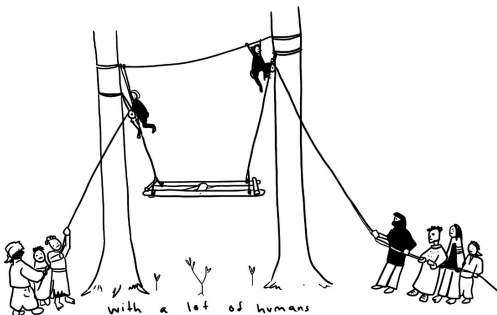

Binding platforms between trees

For building big platforms for communal infrastructure like a kitchen or tool storage it is often the best to bind a platform between multiple trees. Binding platforms between trees is quite self-explanatory but there are a few things which might be nice to know or consider.

When you bind beams between trees you restrict the free movement of the trees. If you don't build too high it should be ok but if you would bind the trees together at a bigger height it can be dangerous. If the trees are fixed too high so they can't move independently with the wind it might result in the top of the tree breaking down and falling on your head. It depends on the diameter and kind of tree you build on but generally speaking between not very thick needle trees it might be wise to not build higher than 5 meters and with big and less moving trees like beeches I wouldn't usually build higher than 7 or 8 meters. But this is just a general estimation. It always depends on the trees.

If the distance between the trees is too high you can support the main beams of the platform by standing support poles. To do so we would dig a hole and ideally put stones or concrete tiles in the bottom of the hole. The stones or tiles are there to prevent the pole from getting easily pushed deeper in the ground. Then we would get a nice beam, peel it and scorch the bottom part of the beam which should be in the ground. We scorch (burn) the poles to make them last longer. If the pole is standing in the ground it will rot quite fast and burning the pole a bit before can slow down this process.

When you have a hole and nice pole you can stand up a pole in the hole and either put it under the main beam of the platform and fix it with a big nail from above or with a couple of nails and screws from underneath. Another option is to have the pole standing next to the main beam, drill a hole through both the standing pole and main beam and fix them together with a bolt. One should use bolts or nails for such connection. Once we fixed a support pole like this by binding it to the main beam with polyprop but after a few months of us living on the tree house the knot slipped down and the support pole broke through the floor of a tree house right underneath a bed where people were sleeping. A peeled pole is too slippery so sooner or later it's likely that the rope will slip down.

It is nice to support big platforms when you build them. We were sometimes lazy to do so and then with time we found out that our main beams were too weak for long distances between trees and had to support them later anyway. It is possible to support it later but if you do it in the first place while building the platform it is much easier. Supporting the platform with standing poles not only ensures that the platform will be safe but also the load of the platform gets more divided and the trees don't need to carry that much. Trees are friends so let's help them with the weight of our houses if we can.

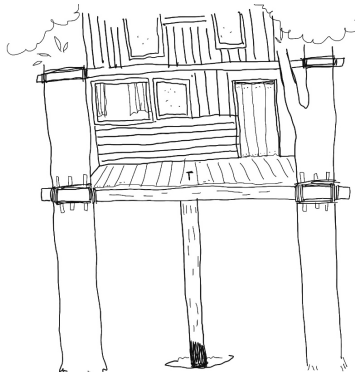

Its nice to build between 4 trees. It is also possible to build triangular platforms just between 3 trees but building on only 3 trees is a bit tricky. At the peak of the triangle you will need to fix both main beams on one and the same tree. There is a special knot for it or you can simple bind one of the beams and hang the other one (which is easier and you need less polyprop for it).

Another issue with triangular platforms is that after you put crossbeams on them you get a platform with very many corners so if you plan to build a tree house with walls it will be very annoying. One of the options how to deal with it would be to put a second layer of crossbeams so that you can have a nice triangle tree house with only 3 corners.

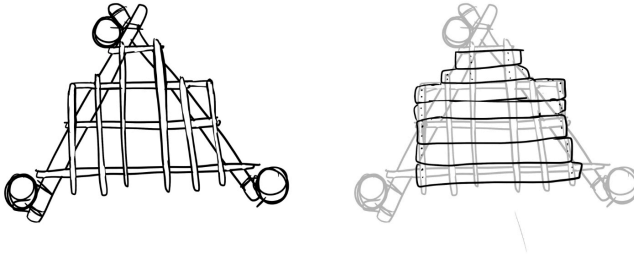

Binding platforms in a canopy

There is not much to say about binding in the canopy. Take care that the branches and tree you build on are safe and go for it. One thing to take into consideration, though, is the location of the tree house relative to the trunk. Try to position your tree house so that its gravitational force is channeled smoothly into the trunk, especially when building a heavy tree house. That means: try to build close to the center of the crown using thick enough branches with a good angle.

A disadvantage of building in the canopy is that the branches will restrict the size of your platform and tree house, but well, living in a canopy is nice and often worth the struggle. When choosing where to attach the main beams, already try to imagine a possible shape for the cabin with enough open space above the beams to work with. For example, make sure to allow at least enough uninterrupted space for a bed!

Building a platform

It is not a very difficult thing but if you want to make it nice there are a few things which might be good to know.

Finding the beams

For building platforms, if we don't have some beams already recycled from somewhere else, we make the beams out of needle trees. Usually we use spruce, but pine or douglas fir are even better. Needle wood is light, strong and flexible. Wood of leaf trees is often heavier and less flexible. If you use a needle tree beam which is not strong enough it will first bend, then make visible cracks and ugly sounds. So if you are attentive you should be able to see if the beam you used is too weak and you need to fix it somehow. In comparison I can imagine for example too weak beech beams to just break without warning. But I don't have experiences with using leaf wood so it's hard to say. Whatever you do, don't use birch.

We usually fell standing dead trees to use for beams. If the tree is laying on the ground it is likely to be already rotting. In contrast trees which are still standing are usually good. Make sure to check that no section has become too soft and weak yet, that no mushrooms grow out of the wood and that all is hard and smooth. If you can choose don't take fresh trees. Sometimes we used beams from trees which fell in a storm. Using fresh wood is shit. It is super heavy and beams are bending a lot. Building with dry wood is much easier and better.

Usually we peel the bark off the beams. Peeled beams last longer and it takes more time for them to rot. When we were kind of sure that the tree houses will get crashed soon by cops we did not peel them but if there is a possibility that the platform will stand for more than a few months you should peel all the important beams, because moisture and tiny animals stay under the bark and the tree rots much faster! You can remove the bark with an axe or hatchet but it is exhausting and time consuming. Organize yourself a sharp peeler (a draw knife).



Arranging the Beams

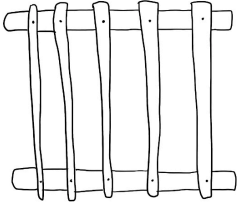

When you are about to fix roundwood crossbeams sort them by their diameter. Put the thickest one on the edge of the platform, then the second thickest, third thickest.... And the thinnest beam on the other side. If you put beams randomly you will have annoying work later and your platform won't be nicely flat. If you use beams from fallen trees, one end is always thicker than the other end. While fixing the crossbeams put all the thicker ends on one side and thin ends on the other side. Again this makes the job of nailing planks easier and your platform will be nicer.

Fixing beams

To fix crossbeams on the main beams we use nails. One could bind it with polyprop but it is shit for putting planks over it and it is just a waste of polyprop. Nails work perfect so we don't need to use ropes made out of plastic which will stay in the environment forever. One big nail for each side of the beam should usually be enough. If you have very thick beams or harder wood (douglas fir) you might need to pre-drill a hole in which you then hit a nail.

We prefer to use nails instead of screws for building platforms. Usual screws are very fragile. If you apply force on it screws can easily break. Nails, which are softer and hence more flexible, will just loosen a bit or bend which makes it better for building platforms. Platforms move a bit so it is good if the connections are a little bit flexible. Nails are also cheaper than screws. The distance you need to leave between crossbeams depends on the planks you are going to use. With weak planks like the ones from pallets (usually not thicker than 2cm) we usually leave 50cm gaps between beams. With good and strong planks we usually leave about 70cm gaps.

The story of MOLD

We used to have a super nice tree house which got at some point issues with water running in and eventually the tree house got renamed Mold. On Mold people had built a platform as big as the canopy of the tree allowed them. When the platform was made they built a tree house on part of it and the other half of the platform was left as a balcony. The problem is that if you have the same floor for the balcony and the house, when it rains on the balcony, depending on (the direction of) the slope, the water may run on the floor inside the tree house. If you have water running to the inside it is possible that the tree house will get moldy. In the case of Mold the lower part of the wall insulation got moldy and a mattress as well. To stop the water from running in, a gutter had to be made. The lesson we got was that on all the next platforms we would separate the balcony and the inside floor with a little gap. When you're building a platform it is good to think which part will be inside the future tree house. On this part try to make straight edges of the platform so that you can then fix the walls from the outside onto the floor boards. If you would have walls sitting on the platform, the water running down from the wall could run onto the floorboards and inside the tree house.

If you have a balcony in the direction of the crossbeams you can simply leave a 10cm gap between the planks where you want to build the front wall. If you have a balcony in the direction of the main beams you might need to put one extra crossbeam to ensure the gap between the balcony and the tree house.

Alternatively, one could arrange the slope of the floor so that water runs off instead of inside the house. This would have to be done from the beginning, when the main beams are attached.

There are a lot of annoying things like that that can be avoided by sitting down before you start building. Make a plan how big you need the space and where to put the beams. Only the mainbeams should touch the tree and only when its bound tightly. Everything that is touching the tree and is not fixed to it, will end up rubbing on it in the wind and create wounds.

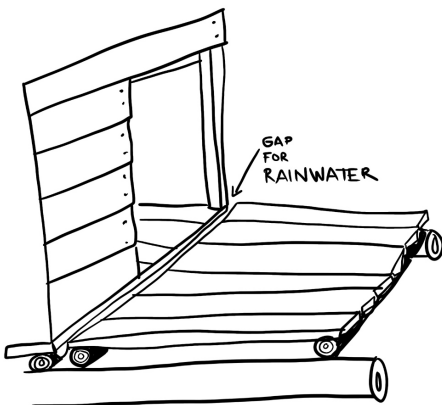

Connections, stability and statics

Connections

To connect different objects there are three different types of connections:

Firmly bonded

This means the two objects connect on an atomic or molecular base and are not able to disconnect without damage/destruction.

Examples are welding or really good gluing.

Form-fitting/ positively

This means the two objects are shaped in a certain way that they "block" each other from moving, even without force applied.

Examples are zippers or tongue and groove systems (Nut und Feder).

Frictional/force locked

This means the two objects are only bound together with applied force.

Examples are if you hold/squeeze something between your fingers or screws.

By definition firmly bonded is the best and is used for example in the process of making construction wood but this is for us simply not possible to do in a safe and reliable way so therefore we have only the other two options.

Form-fitting is nice because it makes it possible to lead some forces from one object to another. When they fit together on a relatively big surface, the material will block by itself instead of only on the surface of some screws or nails, but it's best used in combination. This technique is quite old and very material efficient, but also very time consuming and needs much more skills. Since this process also almost always involves the removal of some material it's unfortunately weakening at least one of the objects and should be used carefully in case statics is involved like for main-, or crossbeams.

For most of the time we are happy with the simple friction of gravity combined with:

- **nails** (better to compensate little movement, rather bends than breaks, but created only little friction)
- **screws** (more friction, but more likely to break with too much movement within the construction, like a banded platform with different moving branches, or a ladder)
- **bolts** (for heavy duty stuff, more reliable because the bolt goes through the whole length of the material and the washers/nuts squeeze it).

This is in theory also form-fitting because of the nails/screws/bolts themselves block the movement within the two different objects, but the main part of the force is taken from the friction between the two objects which the nails/screws/bolts create.

Therefore it's important to **use the friction of gravity** and put weight carrying objects like crossbeams ALWAYS on top of mainbeams and NEVER next to it and only connect it with nails/screws when they are supposed to hold something.

Stability

If you know how to connect things properly you made already the first step of a stable construction and you will easily see the advantage of form-fitting connections, but most of the time this is not necessary and there are other (additional) options. The key part of stability are **TRIANGLES**, they are stable in itself in a certain movement direction and a commonly used to reinforce a construction. Only parallel structures and 90° structures are still able to move but as soon as you stiffen the structure with a diagonal it's suddenly getting way more solid. That does not really need to be a big wooden plank, you can also use metal tape or strings, dependig on what ou are doing. A big thing is also leverage, a small triangle is already good, a big one is super solid. The last, but also most of the time anyway neccessary thing to do to get more stability within a construction, is to plank the construction. If possible its best to use some longer and wider ones, which will reach over the whole construction and not only until the next crossbeam- the more, the better.

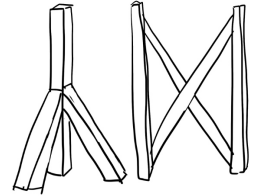

Statics

If you build something on the ground it doesn't matter too much if something is a little too weak. You will maybe even see or hear it before in collapses, or in the worst case only step a little further down. If you build a treehouse it's a different thing, you can't afford to step into a void or risk a collapse of a weight carrying structure. It's therefore a huge responsibility to build something high, because other people usually trust the people who have been building it. Especially if you wanna build big, but with the intention of only few people on the structure: Don't do it! Experience taught us that at latest when the eviction is coming up, there is a big possibility that the whole structure is full of people or other heavy things. If you build something, always estimate with as much people as could possibly fit, calculate and use appropriate material.

Most of the time the people who build treehouses had already some experience, did it at a rough guess or simply oversized it (used material that was stronger than „theoretically“ needed. You can also "test" the beams or constructions while still on the ground or while belayed, but you should keep in mind that we build most of the time with relatively fresh wood, which is still quite heavy but flexible. It is rather flexing instead of breaking, but this is changing over the time if it dries more and will get way more likely to break.

So therefore there are also 2 formulas which will make it easier to be on the safe side on everything concerning carrying construction (mainbeams, crossbeams, planks). Just keep in mind these are actually from carpentry and used with (spruce) construction wood which is usually checked and normed. This means you still have to check (at least!) your weight carrying construction parts for mold, cracks, cuts or weird branch holes! Rather do the work in the beginning and properly, because it's way easier then to replace a beam on an already existing structure, just belief us!

So the easier formular, if we for example use it to figure out which crossbeam to use, is basically the length from one mainbeam to the other (span length) in cm divided by 20. For example if your distance between your mainbeams is 200cm, you need **at least** 10cm high crossbeams. The width of the beam is usually **at least** half of the height, so in this case you would need beams which are at least 200cm long, and 10cm x 5cm (height x width). Since we usually use round beams, it should be fine also fine to take the height of the formula as the diameter of the beams. Round beams have more fibres which are intact compared to rectangular construction wood.

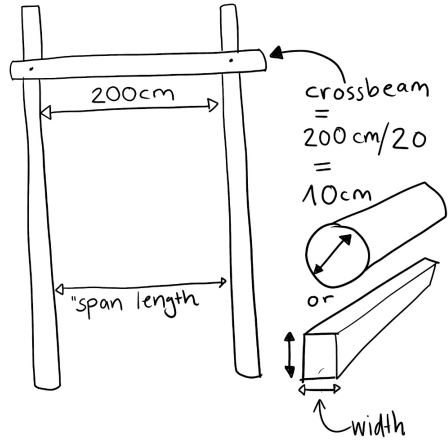

$$\text{span length [cm]} / 20 = \text{height of the beam [cm]}$$

The second formular is meant to calculate the height of beams for a ceiling for a proper house, so you are for sure on the safe side, but the other one is easier and usually does the job for us as well, if everything else is alright with the wood. If you are not sure, rather go closer together with your main beams or find higher/thicker material.

$$\text{height of the ceiling beams [cm]} = L[\text{m}] \times 4 + 4$$

This means for us with the 2m span length ($2\text{m} \times 4 + 4$) a height/diameter of 12cm (width would be 6cm then).

Some values for common span length according to the **second formular**, which would be recommended for a heavier treehouse for permanent living with insulation, windows and so on.

span length -> height

1,5m -----> 10cm

2,0m -----> 12cm

2,5m -----> 14cm

3,0m -----> 16cm

3,5m -----> 18cm

4,0m -----> 20cm

Some values for common span length according to the **first**, easier **formular**, which should be enough for a basic, light treehouse:

span length -> height

1,5m -----> 7,5cm

2,0m -----> 10cm

2,5m -----> 12,5cm

3,0m -----> 15cm

3,5m -----> 17,5cm

4,0m -----> 20cm

Building a treehouse

First you chose a tree and checked if it's healthy. Then you built a nice platform on it and now you probably wanna build a house on top. There is no point in writing a manual on how to build a tree house. Each tree house is different and you can go creative and design it by yourself. Anyway here are a few tips:

Don't hang the roof!

Sometimes people wanna have first a roof and then bother with walls and so they hang or bind the roof on the tree. If you have just an open platform with a roof over it, it is no problem but once you build walls and want to have a closed room it creates troubles. Trees are moving. The higher you go, the more they move. So if you hang or bind a roof let's say 2 or 3 meters above the platform, the roof will move independently from the walls. At best it will creak like hell, at worst it will break. Usually we have only the platform attached to the trees and all the walls and roof fixed to the platform so the whole house moves as one thing. There are plenty of materials to use for covering roof. The easiest way is to skip or steal advertisement tarps. It is nice to first build a roof from planks and put a tarp as a cover on top. If you have only tarp as a roof without wooden layer under, when it is cold, water will condense on a tarp and then drops of water will drop down on you and your sleeping bag.



Other nice material for roofs is a tin roof. Metal roof can't get that easily damaged as a tarp and is much stronger. Problem with a tin roof is that it is very loud. If you live under metal roof each strong rain is a drum concert. Also if you're on oak you will get often awoken by loud sound of acorns falling on the roof. While talking about the roof, its nice to make it steep enough so the water doesnt stay on it and finds its way inside, but flows off in one direction. Also depending on where you are its good if the snow kinda moves off, otherwise the treehouse gets very heavy in winter.

Bending

For the roof, a light and simple method is to make a bending. Ideal for a bending are willow, hazel or chestnut shoots, but also branches from other deciduous trees work. They should not be dead for to long tho. You can also use poles from lost or broken tents and give them a new life. If you can get some punched metal tape, it makes the process way easier!

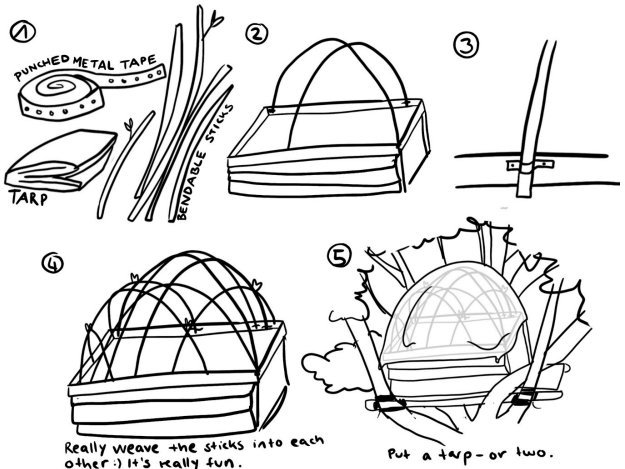

Walls

If you use planks for walls you want to have them overlapping, either horizontally or vertically. If you would put planks just one next to another the wind will blow through the gaps and water might run in.

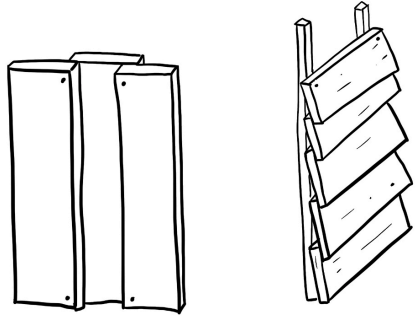

Material

Pallets are easy to get your hands on. They can be taken apart using a mallet, or they can be integrated directly into the walls. Tarps are often donated but can be found as well from advertisement by the road. Re-used lorry tarps are strong and less likely to get punctured by branches than cheap tarps from hardware stores. Otherwise its always good to check out local construction companies trash or ask them about it or go and recycle abandoned buildings.

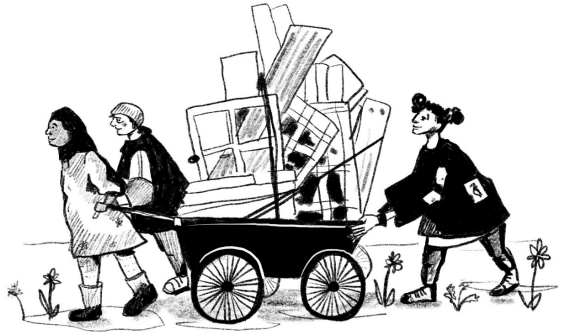

Safety

It might make sense to mark an area under a treehouse construction site so that people know that they should not go there. While building treehouses things sometimes fall so marking the area around as a no-go zone can prevent injuries.

Fire

When installing a wood burner, take normal precautions and do it properly. That means: far enough away from any walls (especially when using straw insulation), use metal plates on the wall behind and on the floor in front and under the burner, make sure the hot pipe does not have direct contact with flammable wall or roof material (wood, straw, tarpaulin,...) where it exits and insulate it with steelwool, etc. There were multiple treehouses in occupations which burned down so be really careful with any kind of fire. Take time to think about a fire concept with your treehouse crew, bring up fire extinguishers, have enough harnesses for everyone, different exits (traverses) from the treehouse and just be really careful- dont light candles without a glass, never leave a fire unwatched!

Respect the host

Do not exaggerate. We have observed a tendency towards ever bigger and heavier tree houses being built in forest occupations. The tenacity and carrying capacity of large trees (see chapter two for species) is great, indeed impressive, but we do not know precisely how great and don't see the need of testing the limits until a crown, including house, perhaps including inhabitants, comes crashing down in a storm.

The higher up in the crown one wants to build, the lighter the construction should be (relative to the size of the tree). Higher up in the tree, the added wind surface and weight will increase the leverage of the wind pulling at the crown significantly more than lower down. Take wind exposure into consideration: is the crown at a lonely height or surrounded by equally tall or taller canopy? (See also chapter three on wind exposure).

Also, as has been mentioned before, the whole weight ultimately hangs in the knots around the cambium of the tree (if rope binding is used to attach the tree house, see chapter four). We have no arboristic data on how much strangulation the sap circulation of trees can deal with. Perhaps it is no coincidence that a marvelous oak in Hambach forest that had an enormous tree house in its crown died for no other apparent reason than the combination of stress factors including drought and heavy burden.

On some trees people often used to free climb by branches up to tree houses. If you often step on branches they get hurt and eventually you might kill the branches. The damage happens surprisingly fast. You can reduce the harm by free climbing without shoes but maybe the best is to not be lazy and climb a rope or ladder. If you want to put a letter its best to not put it against the tree, because that might also hurt the bark, when the tree moves in the wind.

If you regularly piss down from a tree house you will burn the leaves on which the piss falls. Get a piss bucket and empty it somewhere else. Piss buckets are a bit smelly and ugly but you can reduce that. After emptying the bucket just fill it with moss or straw or such. Moss prevents the bad smell. Until the moment when the piss gets above the level of the moss your bucket will have nearly no smell. Even if there are no branches under the tree house it is not nice to piss down all the time. If you piss on the same place every day you can see how the leaves and everything on the ground dies and it is definitely not as good for the soil as when it is spread more evenly.



Insulating a treehouse



If you wanna insulate a tree house you can either use different kinds of insulation produced by industry or you can use a variety of natural materials.

-If you are close to a city you can often easily organize leftovers of **styrofoam** or other insulating materials. An advantage of using styrofoam is that it is very light weight, it insulates well and you can often organize it for free. Also animals don't tend to live in it. Disadvantages are that by cutting styrofoam and working with it you might produce a lot of small plastic waste and pollute your forest with it. In the likely event of eviction, the tree house will be completely shattered, making this problem even worse as the styrofoam gets crushed into small particles. Another disadvantage is that the house can't breath. If you insulate with styrofoam you will basically live in a closed plastic box.

Glasswool is one of the construction industry's many horrible products that is unfortunately very plentiful but therefore also accessible as a leftover of reusable material. It irritates the skin and respiratory organs and is environmentally unfriendly but efficient to install. Just take care that it is sealed into the wall, flying through the air, the tiny pieces can cause lung cancer.

Sometimes people use **rock wool** for insulating around ovens and pipes. Rock wool is heat resistant.

- We sometimes use **straw** for insulating. Straw is easy to get (from farmers or Ende Gelände straw bags) and works pretty well. A disadvantage of straw could be that animals might want to live in it so it might happen that mice, rats or insects will start living in your walls.

- Even better than straw is to use **hemp** insulation. Hemp wool insulates very well and it is easy and pleasant to work with. Another advantage of hemp is that mice and other animals don't like to live in it. If you have a hemp field nearby you can wait until the hemp dries on the field or you dry it by yourself and then you can try to make a hemp wool out of it.

- **Seaweed** insulation is another plant fiber that can be used. It is quite rare to find though.

- Another option would be to use **sheep's wool**. Sheep's wool is fatty so it is less likely to mold. The problem is that it has a strong smell which you might not like, or you might not want to use animal products. Also sometimes moth start living in it!

- Sometimes when we don't want to bother with making proper insulation we just put **blankets or carpets** on the walls. It is of course not insulating so great but it still helps you to not freeze your ass off in winter.

- **Cardboard** can be used as well as an improvised insulation material. It insulates quite well and you can easily get a lot of it in your nearest dumpster.

- If it is election time you can also collect **election posters** of political parties by the road. They are made out of plastic so they should be quite mold-resistant and they have small air chambers so they could be ok insulation material. The problem is that one would need many of them to insulate a tree house with it but well, removing election propaganda is a good action.

When you insulate a tree house you should try to **prevent it from molding**. The problem is that breathing releases humidity in the air and if you have a closed and well insulated tree house the humidity has no way to go out and water will condensate. After a while your tree house might mold. It makes sense to ventilate tree houses often but still in autumn and winter when there are not many sunny days it might not be enough to just open a window from time to time. What helps against the mold is to install a wood burner in your tree house and from time to time warm up the room in order to dry it. If you can't put a burner it can be a challenge to prevent mold. We used to live in a tree house which was insulated with hemp wool. The insulation was great and when there were few people inside, it soon got warm but just in the beginning of winter the ceiling started to mold. The rest of winter we slept usually with open windows so the insulation was a bit useless. If you want to have a warm insulated tree house put a burner there and/or make sure it can breathe and be ventilated well enough.

If you really want to make it proper, its good to **ventilate the wall even from behind**. Especially while insulating a roof its good to leave a gap between the tarp and the insulation, because water will condensate on the cold tarp. You archive that by making two roof constructions. One holds the tarp, one the insulation.

